

CP6036TD Acrylic Roll-In Shower Pan Installation Guidelines

Installation Requirements

- Check to make sure that rough in dimensions of framing studs matches the outside dimensions (OD) of the acrylic pan (37 1/4" x 63 1/2", reference "top view" in illustration box below) **See Figures #1 and #2 on Page 2**
- Pre-Drill holes in acrylic pan top flanges (matching location of stud supports) for connection of acrylic pan to stud supports. The diameter of holes drilled should be the proper size for diameter of fasteners to be used (reference "detail at top flange" in illustration box below) **See Figure #3 on Page 2**
- Check to make sure that area where pan is to be installed is level, free of debris, and that the area where the drain is placed has been chipped out (1/2" deep x 10" diameter). **See Figure #4 on Page 2**

Steps For The Installation Process

- Dry fit acrylic pan into its installation position to ensure proper dimensional fit, that chipped out area at drain location is in correct location and that acrylic pan sits level. **See Figure #5 on Page 2**
- After dry fit is complete, you may grout acrylic pan into place. **Be sure to use a Non-Shrink Grout and mix it extra wet.** After grout is place, make sure pan is level left to right and front to back along top flanges (**do not level at floor of unit as it is angled to direct water to the drain**). All acrylic pans have a 2-degree angle built into them to help direct water to the drain (reference "side view" in illustration box below). **See Figure #6 on Page 2**
- Place a 100lb weight at drain location and additional weights on floor of acrylic pan to help pan adhere to grout.
- Attach acrylic pan to stud supports through pre-drilled holes with fasteners.
- Apply a bead of construction adhesive (1/8") at front flange of acrylic pan to attach front of unit to floor.

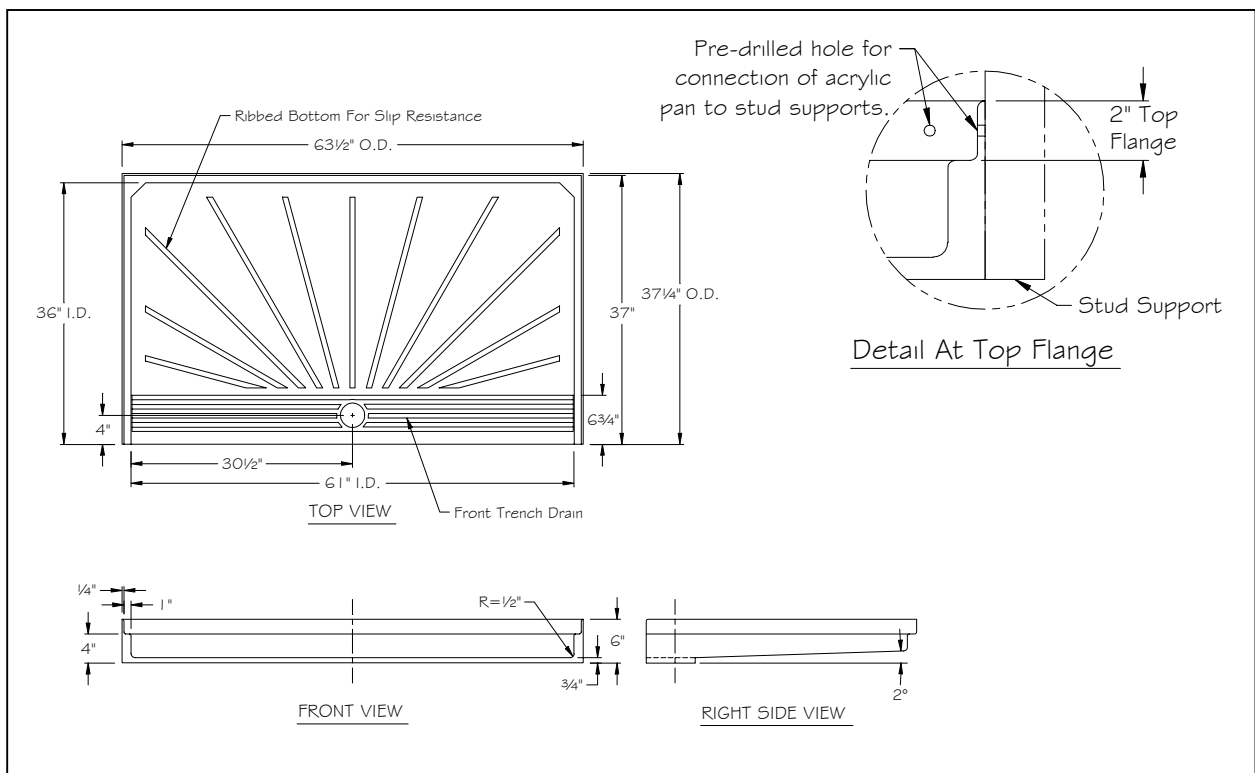

CP6036TD Acrylic Roll-In Shower Pan Installation Guidelines

CP6036TD Acrylic Roll-In Shower Pan Installation Guidelines



Figure #1



Figure #2



Figure #3



Figure #4



Figure #5

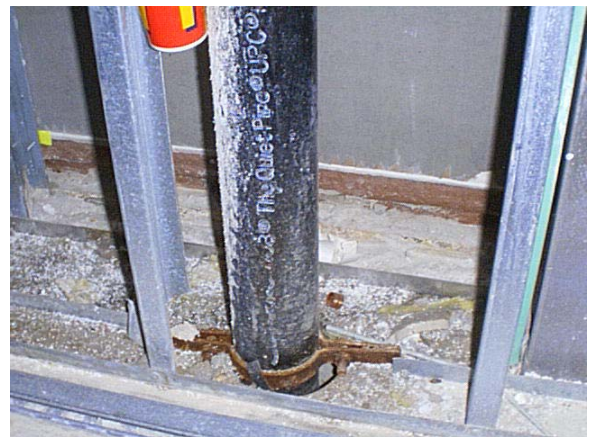

Figure #6

CP6036TD Acrylic Roll-In Shower Pan Installation Guidelines